

Akcia platí
od 05.03.2025
do 31.12.2025
prípadne do
vypredania zásob
PC s DPH



SONNENFLEX



Bezpečnostné opatrenia

	Používajte ochranné okuliare!
	Používajte ochrannú masku!
	Používajte ochranné rukavice!
	Používajte ochranu sluchu!
	Dodržiavajte bezpečnostné odporúčania!
	Nepoužívajte pre ručnú prácu!
	Nepoužívajte pre brúsenie za mokra!
	Nepoužívajte pre brúsenie zo strán!
	Nepoužívajte poškodené kotúče!

Rozmery

Priemer		Hrúbka		Priemer stredového otvoru	
mm	inch	mm	inch	mm	inch
100	4	0,8	.030	10,0	3/8
115	4 1/2	1,0	.040	16,0	5/8
125	5	1,6	.045	20,0	20,0 mm
150	6	1,9	.045	22,23	7/8
180	7	2,0	3/32	25,4	1
230	9	2,5	3/32	32,0	1 1/4
300	12	2,8	3/32		
355	14	3,0	1/8		
400	16	3,2	1/8		
450	18	3,5	1/8		
500	20	4,0	3/16		
600	24	4,4	3/16		
		4,5	3/16		
		6	1/4		
		8			

Bezpečnostné normy

Firma SONNENFLEX vyrába výrobky podľa najvyšších požiadavkov kvality a bezpečnosti v súlade s európskymi a medzinárodnými bezpečnostnými normami.

EN 12413: Európska norma pre lepené / pojivové brusivo.

EN 13743: Európska norma pre lamelové kotúče

Max. otáčky brusiva







Ø mm	Ø inch	Obvodová rýchlosť		
		50 m/s	80 m/s	100 m/s
100	4		15.200	
110	4 3/8	8.500		
115	4 1/2		13.300	
125	5		12.200	
150	6		10.200	
180	7		8.600	
230	9		6.600	
300	12		5.100	6.300
355	14		4.400	5.400
400	16		3.800	



Bezpečnostný kód

Spoločnosti, ktoré sú členom oSa vyrábajú podľa najprísnejších svetových špecifikácií a zaväzujú sa k priebežnej kontrole bezpečnosti výrobkov a monitorovaniu kvality.

Tvar nástroja

F27		Brúsne kotúče
F41		Rezné kotúče, ploché
F42		Rezné kotúče, vypuklé
F11		Hrncové brúsne kotúče
F22		Vulván - fibrové kotúče
F29		Lamelové kotúče, šikmé
F27		Lamelové kotúče, ploché

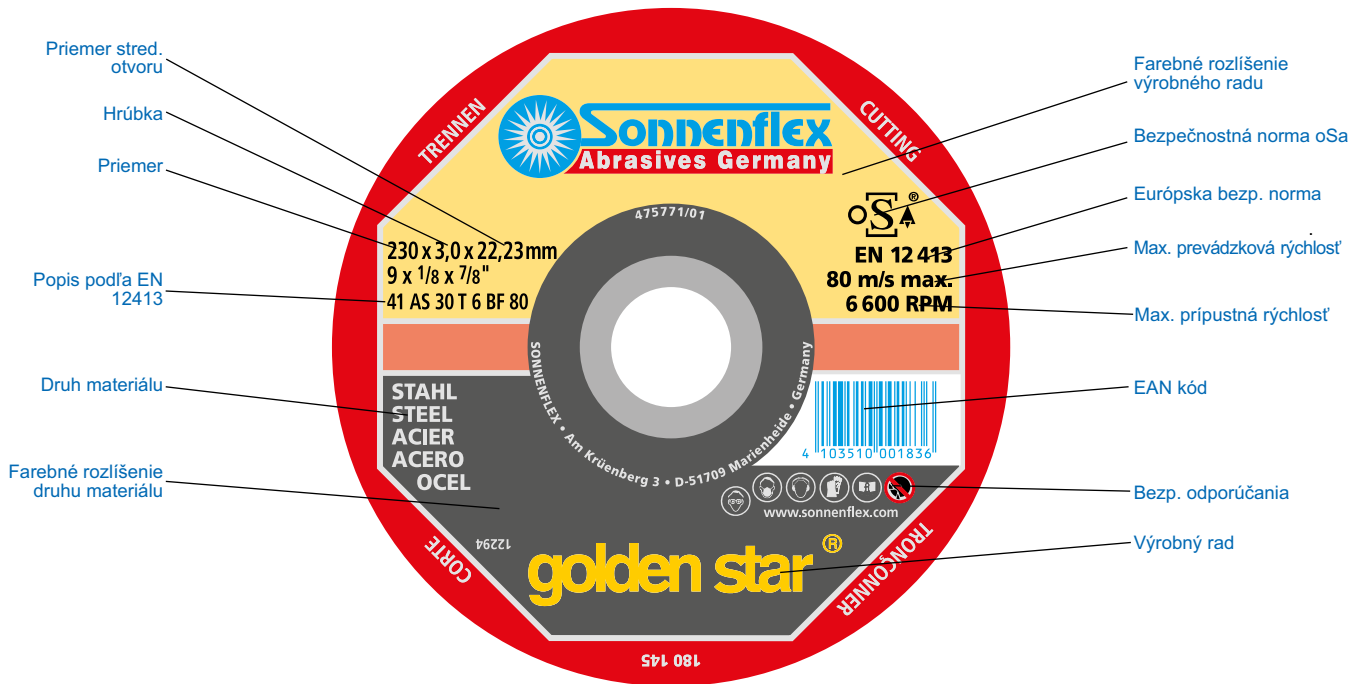



Výklad značenia charakteristík kotúča podľa EN 12413 na príklade 41 AS 30 T 6 BF 80





41	AS	30	T	6	BF	80
Tvar nástroja	Typ zrna	Veľkosť zrna	Tvrdosť	Štruktúra	Pojivo	Max. prevádzková rýchlosť v m/s
F 41 = Rezný kotúč plochý	AS = zušľachtený elektrokorund/oxid hliníka CS = zušľachtený karbid kremíka	16 - 24 = hrubé 30 - 60 = stredné 70 - 220 = jemné	H - K = mäkká L - O = stredná P - S = tvrdá T - W = veľmi tvrdá	1 - 3 = hustá 4 - 5 = stredná 6 - 8 = otvorená 9 - 10 = veľmi otvorená	BF = umelá živica zosilnená sklolaminátovou tkaninou	

Farebný systém rozlíšenia – Použitie jasné na prvý pohľad

golden star[®]

Silverstar[®]

	golden star INOX / Nerezová oceľ	Rezné kotúče Golden star majú vysokú výkonnosť a špičkovú kvalitu pre profesionálne použitie.
	golden star Oceľ	
	golden star Kameň	

	Silverstar INOX / Nerezová oceľ	Rezné kotúče Silverstar sú všeobecne vhodné pre remeselníkov a priemysel s vynikajúcim pomerom cena/výkon.
	Silverstar Oceľ	
	Silverstar Neželezné kovy / Hliník	
	Silverstar Kameň	

REZNÉ KOTÚČE
Nerezová oceľ

Rozmery (mm)	Počet ks v balení	Obj. č.	Cena €
AS 60 Q			
115 x 0,8 x 22,23	25	76710 7	1,54
115 x 1,0 x 22,23	25	76706 0	1,38
125 x 0,8 x 22,23	25	76711 4	1,66
125 x 1,0 x 22,23	25	76707 7	1,54

AS 46 Q

115 x 1,6 x 22,23	25	76703 9	1,54
125 x 1,6 x 22,23	25	77202 6	1,64
150 x 1,6 x 22,23	25	76704 6	1,96

AS 36 S

230 x 1,9 x 22,23	25	00798 2	3,46
-------------------	----	---------	------

Oceľ, legovaná oceľ, liatina
AS 30 T 6 BF

115 x 3,0 x 22,23	25	22301 6	1,48
125 x 3,0 x 22,23	25	22501 0	1,57
230 x 3,0 x 22,23	25	00183 6	3,30
300 x 3,5 x 22,23	25	00483 7	4,81
355 x 3,5 x 25,40	20	65009 6	8,23

Nerezová oceľ
A 60 Q BF

115 x 0,8 x 22,23	50	01036 4	1,13
125 x 0,8 x 22,23	50	01022 7	1,22

AS 24 P BF

115 x 1,0 x 22,23	XLOCK	25	00972 6	1,32
125 x 1,0 x 22,23	XLOCK	25	00973 3	1,44
230 x 2,5 x 22,23		25	00619 0	2,53

Nerezová oceľ, kov
AC 40 R BF

230 x 1,9 x 22,23	25	19333 3	2,45
-------------------	----	---------	------

Hliník, neželezné kovy
CS 46 R BF

115 x 1,0 x 22,23	25	00959 7	0,82
125 x 1,0 x 22,23	25	00961 0	0,89

MINI REZNÝ KOTÚČ
Pre priame brúsky

Rozmery (mm)	RPM	Počet ks v balení	Obj. č.	Cena €
A 46 P BF				
65 x 2,1 x 6,0	23.500	50	00914 6	1,06
76 x 2,1 x 6,0	20.100	50	00917 7	1,57
76 x 2,1 x 10,0	20.100	50	00918 4	1,34

golden star®



Silverstar®

XLOCK

golden star®



REZNÉ KOTÚČE

Nerezová oceľ

Rozmery (mm)	Počet ks v balení	Obj. č.	Cena €
AS 60 P BF ROF			
115 x 1,0 x 22,23	50	19310 4	0,86
125 x 1,0 x 22,23	50	19311 1	0,95
AS 46 P BF ROF			
115 x 1,6 x 22,23	50	19316 6	0,96
125 x 1,6 x 22,23	50	19317 3	1,06
150 x 1,6 x 22,23	25	19323 4	1,82
AS 40 P BF ROF			
230 x 1,9 x 22,23	25	19322 7	2,47
AS 30 P BF ROF			
230 x 3,0 x 22,23	25	19423 1	2,74

Silverstar®



Oceľ, odliatky

AS 60 R BF			
115 x 1,0 x 22,23	50	19010 3	0,84
125 x 1,0 x 22,23	50	19210 7	0,96
AS 46 R BF			
115 x 1,6 x 22,23	50	19216 9	0,96
125 x 1,6 x 22,23	50	19016 5	0,96
AS 40 R BF			
115 x 2,0 x 22,23	25	77002 2	1,18
125 x 2,0 x 22,23	25	77201 9	1,22
150 x 2,0 x 22,23	25	79702 9	1,73
230 x 2,0 x 22,23	25	79801 9	2,24
AS 36 R BF			
115 x 2,5 x 22,23	25	00190 4	1,16
125 x 2,5 x 22,23	25	00192 8	1,22
230 x 3,0 x 22,23	25	00200 0	2,37

Silverstar®



Oceľ, profily, železné tyče

A 30 TBF			
300 x 3,5 x 25,40	25	00404 2	4,81
355 x 3,5 x 25,40	20	00405 9	8,11
A 36 N BF			
300 x 2,8 x 25,40	25	66003 3	4,51
355 x 2,8 x 25,40	25	66001 9	7,95

Silverstar®



REZNÉ KOTUČE V KOVOVÝCH BOXOCH

golden star[®] plus



Obj. číslo	76712D
Rozměry	115 x 1,0 x 22,23 mm
Popis podľa EN 12413	41 AZ 60 W
Počet ks v balení	10
Použitie	nerezová oceľ, oceľ
Cena	16,97 €

Silverstar[®]



Obj. číslo	19310D
Rozměry	115 x 1,0 x 22,23 mm
Popis podľa EN 12413	41 AS 60 P BF
Počet ks v balení	10
Použitie	nerezová oceľ, oceľ
Cena	11,22 €

golden star[®] plus



Obj. číslo	76713D
Rozměry	125 x 1,0 x 22,23 mm
Popis podľa EN 12413	41 AZ 60 W
Počet ks v balení	10
Použitie	nerezová oceľ, oceľ
Cena	18,92 €

Silverstar[®]



Obj. číslo	19311D
Rozměry	125 x 1,0 x 22,23 mm
Popis podľa EN 12413	41 AS 60 P BF
Počet ks v balení	10
Použitie	nerezová oceľ, oceľ
Cena	11,86 €

BRÚSNE KOTÚČE

Nerezová oceľ

golden star®

Rozmery (mm)	Počet ks v balení	Obj. č.	Cena €
AS 30 Q BF ROF			
115 x 6,0 x 22,23	10	00811 8	2,28
125 x 6,0 x 22,23	10	00812 5	2,40
150 x 6,0 x 22,23	10	00813 2	3,69
230 x 6,0 x 22,23	10	00816 3	5,63



Oceľ, legovaná oceľ

AS 24 R 6 BF

115 x 6,0 x 22,23	10	00106 5	2,21
125 x 6,0 x 22,23	10	00107 2	2,40
230 x 6,0 x 22,23	10	10203 8	5,47



Nerezová oceľ

Silverstar®

AS 24 07 BF ROF

115 x 6,0 x 22,23	10	00775 3	1,96
125 x 6,0 x 22,23	10	00776 0	2,12



Oceľ vo všeobecnosti

AS 24 P BF

115 x 6,0 x 22,23	10	00160 7	1,66
125 x 6,0 x 22,23	10	00161 4	1,86
150 x 6,0 x 22,23	10	00163 8	2,28
230 x 6,0 x 22,23	10	00116 4	4,93



HRNCOVÉ BRÚSNE KOTÚČE

Oceľ a liatina

Silverstar®

Rozmery (mm)	Výška segmentu	Počet ks v balení	Obj. č.	Cena €
A 16/24/36 N B				
100/80 x 50 x M14	16	2	00272 7	8,46
100/80 x 50 x M14	36	2	00274 1	8,46



M14

C 16/24/36 N B

100/80 x 50 x M14	16	2	00269 7	8,71
100/80 x 50 x M14	24	2	00270 3	8,71
100/80 x 50 x M14	36	2	00271 0	8,71



M14

LAMELOVÉ KOTUČE

Nerezová ocel', kov, drevo, plasty

golden star®

Rozměry (mm)	Typ zrna	Počet ks v balení	Obj. č.	Cena €
115 x 13 x 22,23	ZK 40 GG	10	96152 9	3,39
115 x 13 x 22,23	ZK 60 GG	10	96154 3	3,39
115 x 13 x 22,23	ZK 80 GG	10	96155 0	3,39
115 x 13 x 22,23	ZK 120 GG	10	96157 4	3,39
125 x 13 x 22,23	ZK 40 GG	10	96160 4	3,69
125 x 13 x 22,23	ZK 60 GG	10	96161 1	3,69
125 x 13 x 22,23	ZK 80 GG	10	96162 8	3,69
125 x 13 x 22,23	ZK 120 GG	10	96163 5	3,69



115 x 13 x 22,23	ZK 40 GG	10	96252 6	2,76
115 x 13 x 22,23	ZK 60 GG	10	96254 0	2,76
115 x 13 x 22,23	ZK 80 GG	10	96255 7	2,76
115 x 13 x 22,23	ZK 120 GG	10	96257 1	2,76
125 x 13 x 22,23	ZK 40 GG	10	96260 1	3,10
125 x 13 x 22,23	ZK 60 GG	10	96261 8	3,10
125 x 13 x 22,23	ZK 80 GG	10	96262 5	3,10
125 x 13 x 22,23	ZK 120 GG	10	96263 2	3,10
125 x 13 x 22,23	ZK 60 GG	10	96461 2	3,10
125 x 13 x 22,23	ZK 80 GG	10	96462 9	3,10



Nerezová ocel', ocel'

115 x 16 x 22,23	ZK 40	10	96365 3	12,44
125 x 16 x 22,23	ZK 40	10	96366 0	13,00



Nerezové povrchy

Rozměry (mm)	Počet ks v balení	Obj. č.	Cena €
125 x 18 x 22,23	5	97053 8	7,49



Silverstar®

Vysoko legovaná a nehrdzavejúca ocel', zliatiny na báze niklu, zliatiny titánu, hliník-železné kovy

Rozměry (mm)	Typ zrna	Počet ks v balení	Obj. č.	Cena €
115 x 13 x 22,23	CO 80 GG	10	00937 5	3,27
125 x 13 x 22,23	CO 80 GG	10	00938 2	3,75



Nehrdzavejúca ocel', kov, drevo, plasty

100 x 13 x 16,0	ZK 40 GG	10	00996 2	2,23
-----------------	----------	----	---------	------



LAMELOVÉ KOTÚČE

Kameň, hliník, plasty

Rozmery (mm)	Typ zrna	Počet ks v balení	Obj. č.	Cena €
115 x 13 x 22,23	SiC 40 GG	10	00077 8	2,24
115 x 13 x 22,23	SiC 60 GG	10	00078 5	2,24
115 x 13 x 22,23	SiC 80 GG	10	00872 9	2,24
125 x 13 x 22,23	SiC 40 GG	10	00079 2	2,66
125 x 13 x 22,23	SiC 60 GG	10	00080 8	2,66
125 x 13 x 22,23	SiC 80 GG	10	00874 3	2,66

Silverstar



Nerez, kov, drevo, plast

115 x 13 x 22,23	ZK 40	10	01006 7	3,03
115 x 13 x 22,23	ZK 60	10	01007 4	3,03
115 x 13 x 22,23	ZK 80	10	01008 1	3,03
115 x 13 x 22,23	ZK 120	10	01009 8	3,03
125 x 13 x 22,23	ZK 40	10	01010 4	3,81
125 x 13 x 22,23	ZK 60	10	01011 1	3,81
125 x 13 x 22,23	ZK 80	10	01012 8	3,81
125 x 13 x 22,23	ZK 120	10	01013 5	3,81

Silverstar Trim

Segment možno spotrebovať až po upínaciu časť kotúča, prípadne orezať na mieru



ČISTIACE KOTÚČE

Na odstraňovanie hrdze, korózie, lepidiel, nečistôt, olejových farieb....

Rozmery (mm)	Počet ks v balení	Obj. č.	Cena €
125 x 13 x 22,23	10	97061 3	9,00

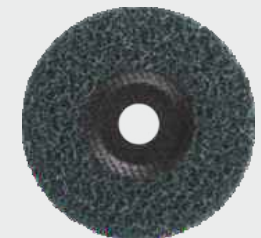

100 x 13 x 6,0	10	00998 6	4,24
150 x 13 x 6,0	10	01000 5	8,52
100 x 13 x 6,0	10	00997 9	4,58
150 x 13 x 6,0	10	00999 3	11,64

Silverstar



PODPORNÝ TANIER

Pre čistiace kotúče 00998 6 - 00999 3

Rozmery (mm)	Počet ks v balení	Obj. č.	Cena €
13 x 6	1	01001 2	8,67



Na brúsenie betónu, plastu, prírodného a umelého kameňa, na čistenie debniacich dosiek, lešení

Rozmery (mm)	Výška segmentu	Počet ks v balení	Obj. č.	Cena €
115 x 22	16	5	00892 7	3,36
115 x 22	24	5	00895 8	3,36
115 x 22	60	5	00899 6	3,36
125 x 22	16	5	00893 4	3,57
125 x 22	24	5	00897 2	3,57
125 x 22	60	5	00900 9	3,57
180 x 22	16	5	00894 1	5,17
180 x 22	24	5	00898 9	5,17
180 x 22	60	5	00901 6	5,17



PODPORNÝ TANIER

Pre čistiace kotúče 00892 - 00901

Rozmery (mm)	Počet ks v balení	Obj. č.	Cena €
115 x M14	1	00062 4	15,24
125 x M14	1	00784 5	18,29
180 x M14	1	00785 2	27,27



BRÚSNE RÚNO

Na ručnú prácu s farbami a kovom

Rozmery (mm)	Veľkosť zrna	Farba	Počet ks v balení	Obj. č.	Cena €
152 x 30	P 320 hrubá	zelená	10	01053 1	9,34
152 x 30	P 360 stredná	hnedá	10	01050 0	10,81
152 x 30	P 1500 jemná	sivá	10	01051 7	10,81
152 x 30	P 2000 extra jemná	zlatá	10	01052 4	9,95
152 x 30	-	biela	10	01100 2	3,38

Silverstar®



FÍBROVÉ KOTÚČE

Nerezová oceľ, liatina, zvary

Rozmery (mm)	Veľkosť zrna	Počet ks v balení	Obj. č.	Cena €
125 x 22/3	ZSE 40	50	00603 9	0,92
125 x 22/3	ZSE 60	50	00604 6	0,77
125 x 22/3	ZSE 80	50	00605 3	0,75

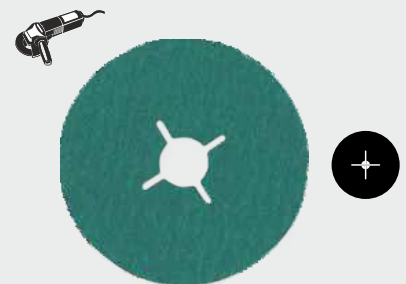

Nerezová oceľ, liatina, zvary, oceľ všeobecne

125 x 22/3	ASE 40	50	00556 8	0,81
125 x 22/3	ASE 60	50	00558 2	0,71
125 x 22/3	ASE 80	50	00559 9	0,69

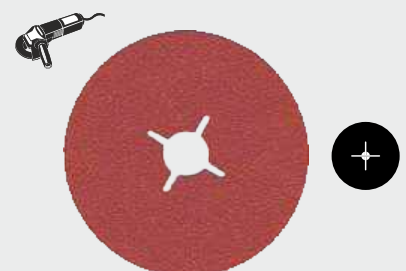

PODPORNÝ TANIER

Pre fibrové kotúče

Rozmery (mm)	Počet ks v balení	Obj. č.	Cena €
125 x M14	1	00461 5	5,15

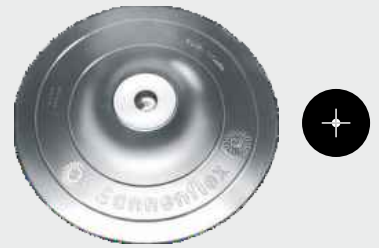

UPÍNACIA MATICA QUICK LOCK

Pre rýchlu beznástrojovú výmenu kotúčov
Pre uhlové brúsky až do Ø 230 mm

M14	1	00047 1	27,26
-----	---	---------	-------



DIAMANTOVÝ SORTIMENT

DIAMANTOVÉ REZNÉ KOTÚČE

golden star®

TOP TRIEDA

UNIVERSAL TURBO

Betón, armovaný betón, škridla, tvrdý prírodný
a umelý kameň, tvrdý kabrinec

Špeciálny kotúč pre rýchlejšie chladenie, vyšší segment.

Rozmery (mm)	Výška segmentu	Počet ks v balení	Obj. č.	Cena €
115 x 2,4 x 22,23	12	1	81031 5	50,55
125 x 2,4 x 22,23	12	1	81032 2	59,80
150 x 2,4 x 22,23	12	1	81037 7	106,67
230 x 2,8 x 22,23	12	1	81034 6	123,22



UNIVERSAL LASER

115 x 2,2 x 22,23	10	1	81110 7	44,72
125 x 2,2 x 22,23	10	1	81111 4	48,35
150 x 2,4 x 22,23	10	1	81112 1	55,84
230 x 2,8 x 22,23	12	1	81114 5	76,17
300 x 3,2 x 25,40	12	1	81118 3	135,23
350 x 3,2 x 25,40	12	1	81120 6	152,56
400 x 3,2 x 25,40	12	1	81124 4	247,13
81114 + 00047	12	1	00664	88,95

Matica Quick Lock v cene



Betón, armovaný betón, škridla, kameň

250 x 3,0 x 25,40	10	1	01041 8	221,19
-------------------	----	---	---------	--------

PORCELAIN TILES

Keramické obklady, gres, dlažby, žula, keramika,
kabrinec, mramor, prírodný a umelý kameň

115 x 1,2 x 22,23	7	1	81250 0	17,37
125 x 1,2 x 22,23	7	1	81251 7	21,75



golden star®

Porcelán a dlaždice, gres, keramika, mramor, žula

Rozmery (mm)	Výška segmentu	Počet ks v balení	Obj. č.	Cena €
115 x 1,5 x 22,23	11	1	01047 0	40,61
125 x 1,5 x 22,23	11	1	01048 7	45,14



Silverstar®

115 x 1,6 x 22,23	11	1	81201 2	14,55
125 x 1,6 x 22,23	11	1	81202 9	17,33
180 x 1,6 x 22,23	11	1	81207 4	29,22
200 x 1,7 x 25,40	11	1	81040 7	39,50
250 x 1,8 x 22,23	11	1	81041 4	63,87



UNIVERSAL TURBO

Betón, armovaný betón, škridla, stredne tvrdý prírodný a umelý kameň, stredne tvrdý kabrinec

Diamantové výbežky na kotúči zrýchľujú a uľahčujú prácu.

115 x 2,7 x 22,23	8	1	87600 7	15,45
125 x 2,8 x 22,23	8	1	87601 4	17,82
150 x 3,0 x 22,23	8	1	87602 1	29,59
230 x 3,2 x 22,23	8	1	87604 5	50,42



UNIVERSAL LASER

Betón, všeobecné použitie

115 x 2,0 x 22,23	10	1	81001 8	19,63
125 x 2,0 x 22,23	10	1	81002 5	22,35
230 x 2,4 x 22,23	10	1	81004 9	41,98
300 x 2,8 x 22,23	10	1	81800 7	83,65
350 x 2,8 x 25,40	10	1	81804 5	113,95



LASER ASPHALT

Asfalt, abrazívne materiály, čerstvý betón, stierka, plynobetón, šamotové tehly

Kotúč navrhnutý pre rezanie asfaltu so segmentmi spájkovanými laserom.

350 x 3,0 x 25,40	10	1	81504 4	208,37
450 x 3,5 x 25,40	10	1	81506 8	264,43



Silverstar®

ECO TRIEDA

UNIVERSAL ECO

Betón, všeobecné použitie

Rozmery (mm)	Výška segmentu	Počet ks v balení	Obj. č.	Cena €
115 x 2,0 x 22,23	7	1	83101 3	6,36
125 x 2,0 x 22,23	7	1	83102 0	6,89
230 x 2,6 x 22,23	7,5	1	83104 4	17,71



UNIVERSAL TURBO ECO

Betón, červené tehly, prírodný a umelý kameň, obkladačky, dlažba

115 x 22,23	4,5	1	87630 4	6,56
125 x 22,23	5	1	87631 1	7,22
230 x 22,23	9	1	87634 2	21,91



TILES ECO

Dlažba

115 x 2,0 x 22,23	5	1	81209 8	4,45
125 x 2,0 x 22,23	5	1	81210 4	4,87



DIAMANTOVÉ BRÚSNE KOTUČE

HRNCOVÉ, JEDNORADOVÉ

Betón, žula, všeobecné použitie

125 x 22,23	5	1	81081 0	61,61
180 x 22,23	5	1	81083 4	93,66

Silverstar®



HRNCOVÉ, DVOJRADOVÉ

Betón, žula, všeobecné použitie

125 x 22,23	5	1	81085 8	78,09
180 x 22,23	5	1	81087 2	105,62

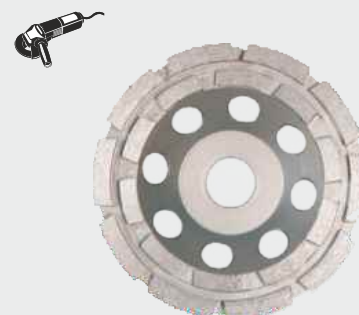

HRNCOVÝ, ŠPECIÁLNY

Špeciálny segment, na betón, abrazívne materiály

125 x 20 x 22,23	5	1	01028 9	47,86
------------------	---	---	---------	-------



DIAMANTOVÉ BRÚSNE KOTÚČE

golden star®

HRNCOVÉ, JEDNORADOVÉ

Betón, všeobecné použitie

Rozmery (mm)	Výška segmentu	Počet ks v balení	Obj. č.	Cena €
115 x 20 x 22,23	5	1	01002 9	52,99



HRNCOVÉ, DVOJRADOVÉ

Betón, všeobecné použitie

115 x 20 x 22,23	5	1	01003 6	74,85
------------------	---	---	---------	-------



HRNCOVÉ, DVOJRADOVÉ

Betón, všeobecné použitie

115 x 22,23	5	1	00108 9	31,99
125 x 22,23	5	1	00109 6	41,84
150 x 22,23	5	1	00118 8	42,98
180 x 22,23	5	1	00119 5	83,82



HRNCOVÉ, TURBO

Betón, všeobecné použitie

115 x 22,23	5	1	00801 9	32,58
125 x 22,23	5	1	00800 2	40,64



KEFY

RUČNÁ KEFA S ROVNÝM DRÔTOM

4-RADOVÁ S DREVENOU RUKOVÄŤOU

Pre čistenie, odstraňovanie hrdze a náterov.

Drôt	Počet ks v balení	Obj. č.	Cena € / 1 ks
ocel 0,35 mm	12	00669 5	1,94
nerez 0,30 mm	12	00672 5	6,10



RUČNÁ KEFA SO ZVLNENÝM DRÔTOM

KEFA S PLASTOVOU RUKOVÄŤOU

Pre čistenie, odstraňovanie hrdze a náterov, Ø drôtu 0,30 mm.

Dĺžka celková / pracovná	Počet ks v balení	Obj. č.	Cena € / 1 ks
290 / 140 ocel'	20	00644 2	3,03
290 / 140 nerez	20	00645 9	3,83
290 / 140 mosadz	20	00646 6	4,75



HRNCOVÉ KEFY

SO SPLETANÝM DRÔTOM

Na odstraňovanie náterov, nerovností, hrdze a čistenie zvarov, Ø drôtu 0,50 mm.

Ø kefy x závit	Počet ks v balení	Obj. č.	Cena € / 1 ks
65 x M14 ocel'	15	00612 1	6,85
65 x M14 nerez	15	00625 1	11,73



SO SPLETANÝM DRÔTOM

Na odstraňovanie náterov, korózie, hrdze a všeobecné vyhladzovanie, Ø drôtu 0,30 mm.

60 x M14 ocel'	15	99022 2	5,79
60 x M14 nerez	15	00629 9	7,22



STOPKOVÁ KEFA

SO ZVLNENÝM DRÔTOM

Pre prípravu všetkých druhov povrchov a ťažko prístupných miestach, pre vyhladzovanie, úpravu zliatinových, gumených a kovových spojov, ľahké odhroťovanie a odstraňovanie hrdze a náterov, Ø drôtu 0,30 mm.

Ø kefy	Počet ks v balení	Obj. č.	Cena € / 1 ks
22 oceľ	80	00647 3	2,71



KOTÚČOVÁ KEFA SO STOPKOU

SO ZVLNENÝM DRÔTOM

Pre prípravu všetkých druhov povrchov a ťažko prístupných miestach, pre vyhladzovanie, úpravu zliatinových, gumených a kovových spojov, ľahké odhroťovanie a odstraňovanie hrdze a náterov, Ø drôtu 0,30 mm.

Ø / šírka kefy	Počet ks v balení	Obj. č.	Cena € / 1 ks
50 / 8	80	00648 0	1,39
50 / 15	40	00649 7	3,03
75 / 10	40	00651 0	1,91
75 / 15	40	00653 4	4,22
100 / 12	20	00656 5	2,51



STD TWISTED UNI

Rozmery (mm)	Počet ks v balení	Obj. č.	Cena €
115 x M14	1	00804 0	9,07

